

REVISION HISTORY			
Rev	DESCRIPTION	DATE	APPROVED
△1	Changed Detail Q ;	Apr 19 2017	Z.zhang

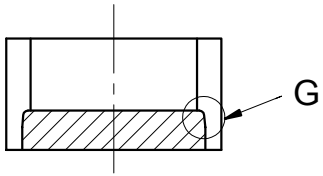

Section E-E

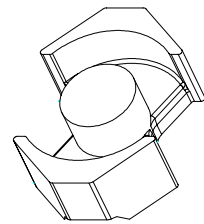
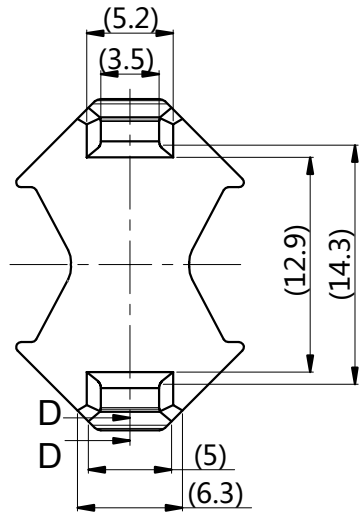
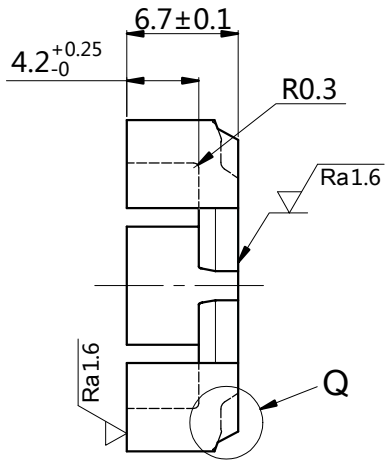
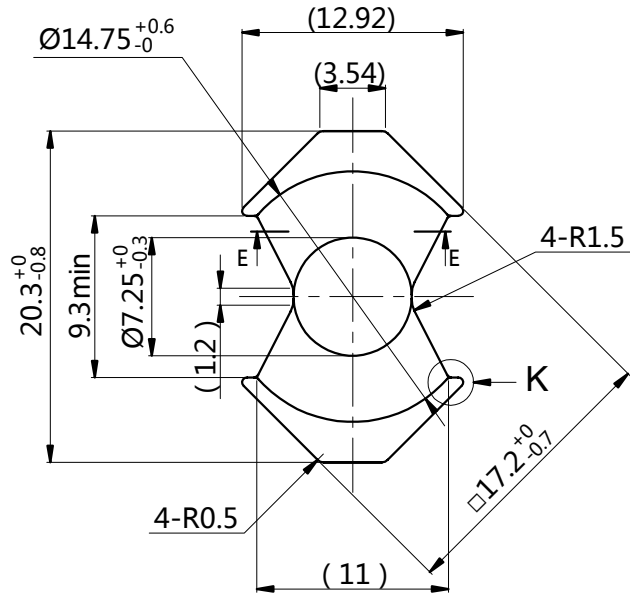
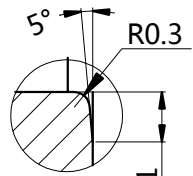

Detail G

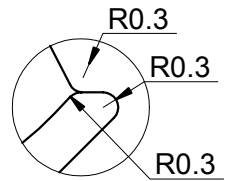

Detail K

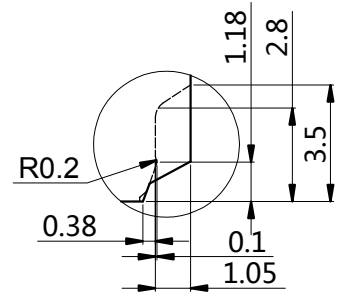

△1 Detail Q

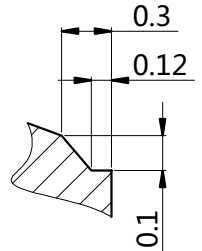

Section D-D

	Scale	Material	Customer Part number	
	2.5 : 1			
Unit: mm	Standard tolerances	Product Name		
	±0.1	RM-7S		
Approved by	Created by	Document type	Rev	Drawing No.
Y.Higuchi	Z.zhang	Production drawing	01	PY161117M01
Hitachi Metals (Hong kong) Ltd. Panyu Factory			Date of issue	Sheet
			Apr 19 2017	1/1